

**RADIO CONTROLLED WIRELESS WEATHER
STATION**

User's instructions

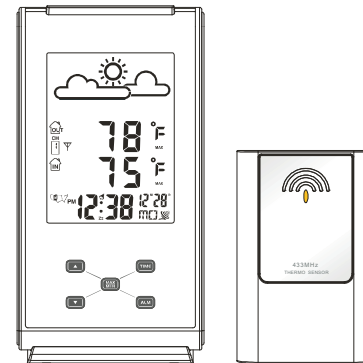

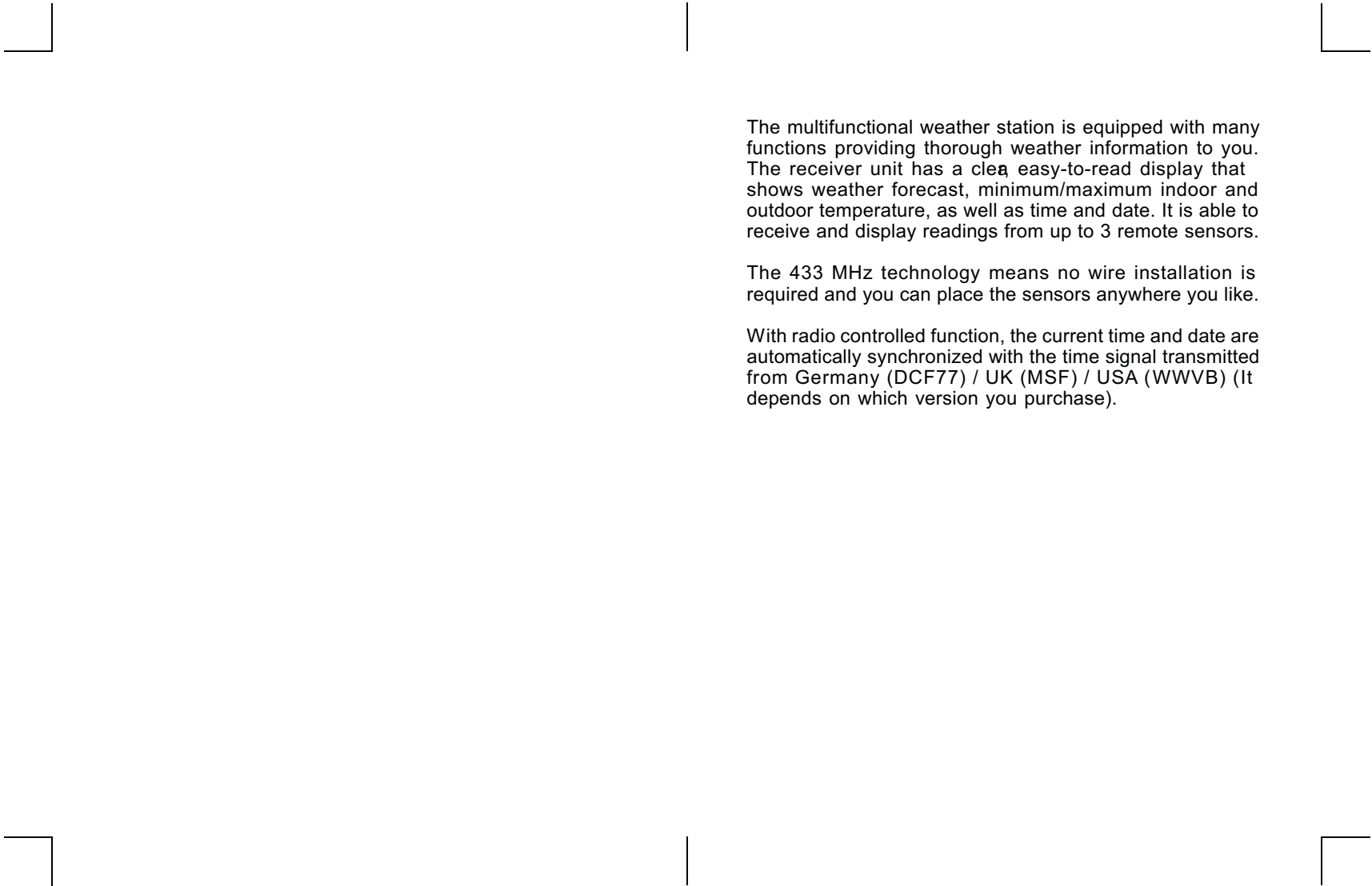



The multifunctional weather station is equipped with many functions providing thorough weather information to you. The receiver unit has a clear easy-to-read display that shows weather forecast, minimum/maximum indoor and outdoor temperature, as well as time and date. It is able to receive and display readings from up to 3 remote sensors.

The 433 MHz technology means no wire installation is required and you can place the sensors anywhere you like.

With radio controlled function, the current time and date are automatically synchronized with the time signal transmitted from Germany (DCF77) / UK (MSF) / USA (WWVB) (It depends on which version you purchase).

MAIN FEATHERS:
WEATHER STATION:

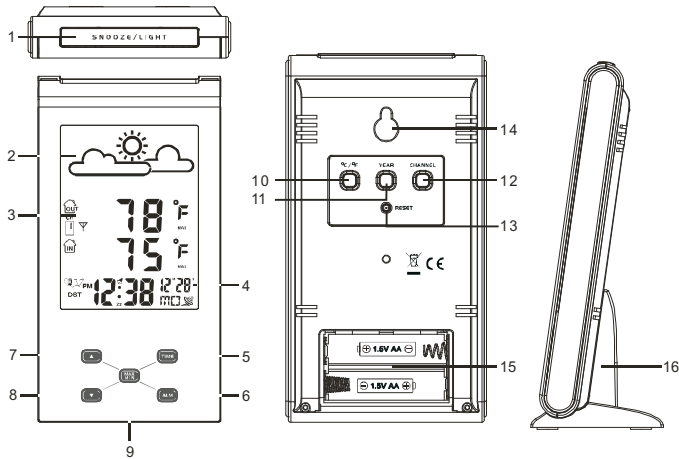

1. SNOOZE/LIGHT:

- Press it once to turn on the backlight for 5 seconds.
- Press it to stop the alarm when it is sounding

2. WEATHER INDICATOR WINDOW:

- Shows the weather forecast indicators and moon phase.

3. TEMPERATURE WINDOW:

- Shows the indoor and outdoor temperature.

- No. of remote unit: up to 3 units
- RF transmission range: maximum 80 meters free field
- Temperature sensing cycle: around 60-64 seconds
- Radio controlled signal: DCF

POWER

- Main unit: 3V, use 2 xAA 1.5V alkaline battery
- Remote sensor: 3V, use 2 xAA 1.5V alkaline battery

DIMENSION

- Main unit: 86(W) x 164(H) x 60(D) mm
- Remote sensor: 65(W) x 115(H) x 20(D) mm

USING THE TABLE STAND OR WALL MOUNTING

The receiver has both desktop and wall-mounting structure. Place the screw on the desired wall and hang the clock by the wall mount in the back of it or just simply place it on the desktop by its table stand.

For the transmitter, fix the wall-mount holder on the wall or simply place it on the table.

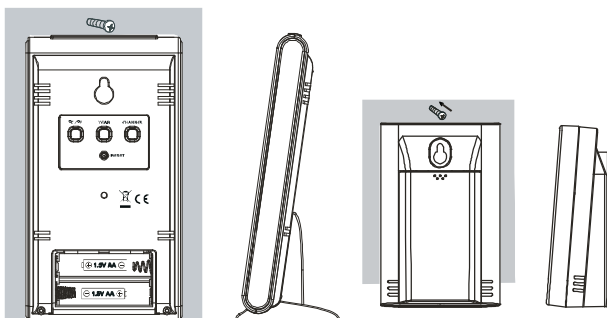

SPECIFICATIONS

MAIN UNIT

Recommended operating range: 0°C to 45°C
32°F to 113°F

Resolution: 0.1°C/1°F (above 0°C/32°F)
1°C/°F (below 0°C/32°F)

RF transmission frequency: 433MHz

4. CLOCK TIME WINDOW

- Displays normal time, alarm time, date and day of the week.

5. TIME key:

- Press and hold it for 2 seconds to enter normal time setting.
- In normal time setting, press it to step the setting items.

6. ALM key

- Press it to switch between Month/Date and alarm time mode.
- Press it to stop the current alarm when the bell is ringing and turn off the alarm and snooze function.
- In alarm time mode, press and hold it for 2 seconds to enter alarm time setting.

7. UP key

- In setting mode, press it to increase the setting values.
- In normal time mode, press it to switch among Channel 1, 2 and 3.
- In alarm time mode, press it to turn on/off the Alarm and Snooze.

8. DOWN key

- In setting mode, press it to decrease the setting values.
- In normal time mode, press it to switch between Second and Day of the week display.

9. MAX/MIN key

- Press it to check the minimum and maximum temperature records.

- Press and hold it for 3 seconds to delete the minimum and maximum temperature records.

10. °C/°F key

- Press it to switch between Celsius and Fahrenheit.
- Press and hold it for 3 seconds to receive the RC signal for reception testing.

11. YEAR key

- Press it to switch between Month/Date and Year display.

12. CHANNEL key

- In setting mode, press it to increase the setting values.
- In normal time mode, press it to switch among Channel 1, 2 and 3.
- In alarm time mode, press it to turn on/off the Alarm and Snooze.

13. RESET key

- Press it to set all values to default values.
- In case of mal-function, the unit may be required to reset.

14. WALL-MOUNTING HOLDER

- Use it to support the main unit on the wall.

15. BATTERY DOOR

16. TABLE STAND

- Use it to stand the clock on the desktop.

on the weather. In bad weather the displays will not appear.

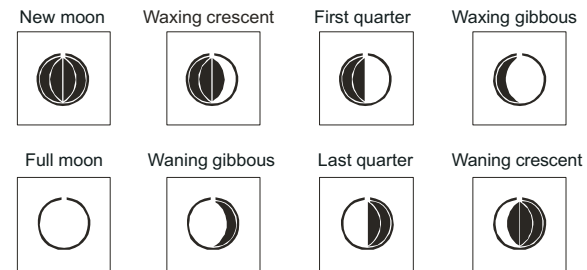

BATTERY REPLACEMENT

When the LCD becomes dim, replace with 2 new AA size batteries at once; while if the low battery indicator “” displays in the channel window, it indicates that the battery power of the transmitter is not enough, and you should replace with 2 x AA size batteries at once.

Transmitter's low battery indicator



NOTE:

Attention! Please dispose of used unit or batteries in an ecologically safe manner.



thoroughly. Try out where the station receives the signals best.

CHECKING AND DELETING MAX/MIN TEMPERATURE RECORDS

1. Press "MAX/MIN" key once to check the maximum temperature records. Press it twice to check the minimum records. Press it again to exit.
2. Press and hold "MAX/MIN" for 3 seconds to delete the maximum and minimum temperature records with "beep" tone.

MAX. Temperature records MIN. Temperature records

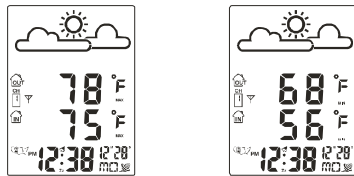

ABOUT THE MOON PHASE

The unit has 8 different moon phases. It will change according to the lunar calendar.

NOTE

1. The icon of the sun will be displayed from 6am to 8pm, the moon phase and stars will be displayed from 8pm to 6am.
2. Display of the sun, moon phase and the stars depends

TRANSMITTER

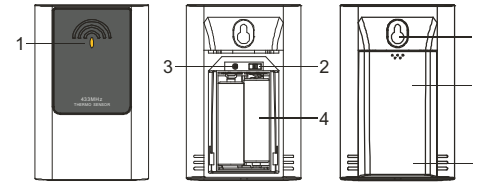

1. LED indicator:
 - Flashes when the remote unit transmits a reading.
2. CHANNEL SLIDE SWITCH:
 - Assign the transmitter to Channel 1, 2 or 3.
3. RESET:
 - Press it to restart the transmitter.
4. BATTERY COMPARTMENT:
 - Accommodates 2 x AA size batteries.
5. BATTERY DOOR
6. WALL-MOUNTING HOLDER:
 - Use it to support the transmitter on the wall.
7. TABLE STAND:
 - Use it to stand the transmitter on the desktop.

BEFORE USING THE TRANSMITTER

1. Remove the battery door.

2. Insert 2 x AA size batteries into the battery compartment. Make sure you insert them the right way according to the polarity information marked on the battery compartment.
3. Replace the battery door.

NOTE:

1. Once the channel is assigned to one transmitter, you can only change it by removing the batteries or resetting the unit.
2. Avoid placing the transmitter in direct sunlight, rain or snow.

WEATHER STATION:

1. Remove the battery door and insert 2 x AA batteries into the battery compartment. Make sure you insert the batteries the right way according to the polarity information marked on the battery compartment.
2. Replace the battery door.
3. Press the "RESET" key to re-start the clock and it will synchronize the channels of transmitter automatically.

NOTE:

1. The building material and the position of the receiver and transmitter affect the effective range. So try various locations to obtain the best result.
2. Place the units away from metal objects and electrical appliances to minimize the interference. Position the receiver and transmitter within the effective transmission range: 80m free field in usual circumstances.

NOTE:

1. The alarm and snooze will be automatically turned on when setting the alarm time.
2. Once the snooze is turned on, the 4-step crescendo alarm will sound 4 times in 5-minute interval. The alarm duration is 60 seconds.
3. Pressing the "SNOOZE/LIGHT" key can stop the current alarm and enter the snooze mode; while pressing the "ALM" key can not only stop the alarm but also turn off the snooze function.

VIEW THE CHANNEL

The default channel is Channel 1. In normal time mode, press "UP" or "CHANNEL" key to view the channel from 1 to 3. Besides, the channels can automatically switch by pressing and holding the "UP" or "CHANNEL" key for 3 seconds.

READING INDOOR/OUTDOOR TEMPERATURE RECORDS

Change the temperature unit to °C for Celsius or °F for Fahrenheit by pressing "°C/°F" key.

NOTE:

1. If no signals are received or the transmission is interfered, "—" will appear on the LCD.
2. Relocate the clock or transmitter in other positions and make sure the transmission is within the effective range of 80m approx.
3. After several trails in vain, please reset the clock

- The 5 languages weekday settings are represented by the below abbreviations: GB= English FR= French DE=German ES= Spanish IT= Italian
- Press "TIME" key to confirm and exit the setting or let it exit automatically 30 seconds later without pressing any key.

English	French	German	Spanish	Italian
SU	DI	SO	DO	DO
MO	LU	MO	LU	LU
TU	MA	DI	MA	MA
WE	ME	MI	MI	ME
TH	JE	DO	JU	GI
FR	VE	FR	VI	VE
SA	SA	SA	SA	SA

ALARM AND SNOOZE SETTING

- In normal time mode, press "ALM" key to enter the alarm time mode.
- In alarm time mode, press "UP" key to turn on the alarm and snooze with the bell icon "🔔" and snooze icon "Zz" displayed together on the LCD.
- In alarm time mode, press and hold "ALM" key for 2 seconds to enter alarm time setting mode until the alarm Hour digit flashes.
- Press "UP" or "DOWN" key to change the value of the flashing Hour digit.
- Repeat the above operation to set the alarm Minute.
- After complete all settings, press "ALM" key to exit the setting, or let it exit automatically 30 seconds later without pressing any key.

ABOUT THE WEATHER INDICATOR

The built-in barometer can notice atmospheric pressure changes. Based on the data collected, it can predict the weather conditions in the forthcoming 12-24 hours.

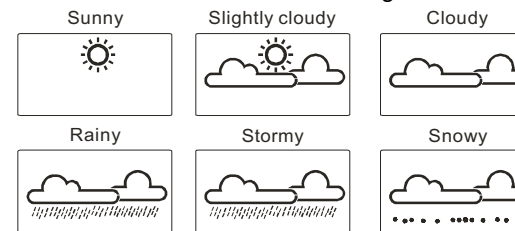

NOTE:

- The accuracy of a general pressure-based weather forecast is about 70% to 75%.
- The weather forecast is meant for next 12 to 24 hours, it may not necessarily reflect the current situation.
- The "Snowy" weather forecast is not based on the atmosphere pressure, but based on the outdoor temperature. When the outdoor temperature is below -3°C (26°F), the "Snowy" weather indicator will be displayed on the LCD.

RECEPTION OF RADIO CONTROLLED TIME SIGNAL

The time and date are radio-controlled. The current time and date are automatically synchronized with the time signal transmitted from Germany (DCF 77)

When used for the first time (after inserting the batteries or pressing the "RESET" key), the clock will start to receive the RC signal in 5 minutes with the signal strength indicator flashing.

SIGNAL STRENGTH INDICATOR

The signal indicator displays signal strength in 3 levels. Wave segment flashing means time signals are being received. The signal quality could be classified into three types:



NOTE:

1. Everyday the unit will automatically search for the time signal at 2:00, 8:00, 14:00 and 20:00.
2. Always place the unit away from interfering sources such as TV set, computer, etc.
3. Avoid placing the unit on or next to metal plate.
4. Closed area such as airport, basement, tower block or factory is not recommended.
5. Do not start reception on a moving article such as vehicle or train.



DAYLIGHT SAVINGS TIME (DST)

The clock has been programmed automatically to switch when the daylight savings time is in effect. Your clock will show "DST" during the summer.

MANUAL TIME AND CALENDAR SETTING

If you are out of the reach of the Radio Controlled Transmitter or if the reception is not reachable, the time can be set manually. As soon as the signal of transmitter is received again, the clock will automatically synchronize with the exact time.

1. In normal time mode, press and hold the "TIME" key for 2 seconds until the HOUR digit flashes.
2. Press the "UP" or "DOWN" key to change the value of the flashing HOUR digit.
3. Repeat the above operation to set the time and calendar in this order: Hour > Minute > Second > 12/24 Hr > Year > Month > Date > Day language.