

# WS6850 Desktop Weather Station

## Instruction Manual

### Introduction

This desktop weather station comes with barometric weather prediction, clock, calendar, indoor and outdoor temperature and humidity display. It is battery powered with AC charger. It is recommended to use the AC charger at all times.

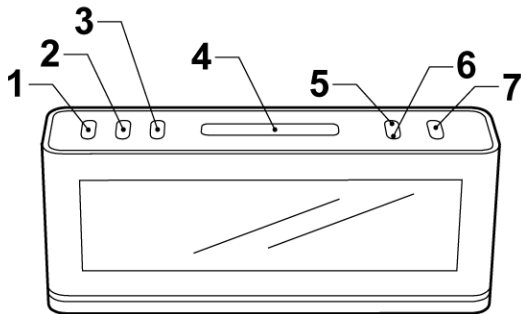

Fig. 1 Front view

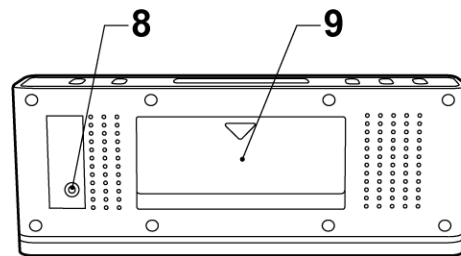

Fig. 2 Back view

1. MODE button
2. +/-C/+F button
3. -/RCC button
4. SNOOZE/ LIGHT button
5. HISTORY button
6. CHANNEL button
7. MAX/ MIN button
8. DC line in jack
9. Battery compartment

### General notes:

1. It is recommended to set up the remote temperature sensor before setting up the weather station/ clock. See “**Configuring Remote Temperature Sensor(s)**” for more information. Batteries and AC adapter should be used together.
2. Please note all other clock/ weather station settings cease to function when the clock is in RCC synchronization mode. See “**RCC Synchronization**” for additional information.
3. During initial installation, the temperature and humidity sensor may take up to an hour or more to acclimatize to current conditions.
4. Press **SNOOZE/ LIGHT** (4) to change LCD screen backlight brightness from **OFF**, **LOW** and **HIGH**.

### Getting started:

Installing AC adapter

1. Plug in AC/DC adapter at DC input jack (8) (see fig. 2). Use only approved adapters.

#### Batteries installation

1. Open battery compartment (9) on the back of the unit (see fig. 2).
2. Install/ replace 2 x AAA size batteries in the compartment. It is recommended that only alkaline batteries are used.
3. Replace the battery compartment (9) on the back of the unit.
4. A short beep will be heard to confirm proper installation of batteries.
5. It will take approximately 3 seconds for the screen to light up.



6. Replace batteries when this symbol is shown. This indicates low batteries.

#### Batteries safety warnings:

1. Please read all instructions carefully before use.
2. Install batteries correctly by matching the polarities (+/-).
3. Always replace a complete set of batteries.
4. Never mix used and new batteries.
5. Remove exhausted batteries immediately.
6. Remove batteries when not in use.
7. Do not recharge and do not dispose of batteries in fire as the batteries may explode.
8. Ensure batteries are stored away from metal objects as contact may cause a short circuit.
9. Avoid exposing batteries to temperature or humidity extremes or direct sunlight.
10. Keep all batteries out of reach from children. They are a choking hazard.
11. Please retain packaging for future reference.

#### Setting up the weather station:

The weather station will sound once batteries are installed or ac adapter is plugged in.

1. The double digits of sea level on the bottom left hand corner of the display will flash. Press **+°C/°F** button (2) or **-/ RCC** button (3) to change the sea level closest to your location. The sea level units are in meters (1 meter equals approximately 3.28 feet). Contact your local weather bureaus or authorities for more information.
2. Press **HISTORY** button (5) to confirm sea level.
3. Press **+°C/°F** button (2) or **-/ RCC** button (3) to change the current weather situation of your location. See figure 3 below for the weather pattern that is resembles your immediate area.





Sunny	Slightly Cloudy	Cloudy	Rainy
			

Fig. 3 Weather pattern

4. Press **HISTORY** button (5) to confirm weather pattern.

### **Interpreting the weather forecast symbols**

The weather station requires at least 24 hours on acclimatizing to local weather conditions. The weather station process and analyze the weather patterns for the past 24 hours in order to determine the future weather. Until that time has elapsed, the predicted weather forecast may not accurately reflect the actual weather for your immediate area.

The weather station will display the symbols (see fig. 3) to indicate the predicted weather forecast for the next 12 to 24 hours for an area within a radius of approximately 30-50 km.

#### **Note:**

1. Accuracy rate might be lower in extreme weather conditions. The weather forecast is only for reference only and it is only for domestic use only. Do **NOT** rely on the weather station for weather forecast if any serious matter relies on it including but not limited to: personal health, life and death situation, any business or financial decisions, and/or agricultural planning.
2. The weather forecast does not display the current weather. It displays the weather for the future.

### **Adjusting the weather station:**

1. Press **HISTORY** button (5) for 3 seconds until a beep sound is heard.
2. Press **+/<sup>o</sup>C/<sup>o</sup>F** button (2) or **-/ RCC** button (3) to toggle between atmospheric pressure units of Pascal (hPa) to inch of mercury (inHg)
3. Press **HISTORY** button (5) to confirm.
4. Press **+/<sup>o</sup>C/<sup>o</sup>F** button (2) or **-/ RCC** button (3) to toggle between absolute and relative atmospheric pressure.
5. Press **HISTORY** button (5) to confirm.
6. Press **+/<sup>o</sup>C/<sup>o</sup>F** button (2) or **-/ RCC** button (3) to change the sea level closest to your location.
7. Press **HISTORY** button (5) to confirm sea level.
8. Press **+/<sup>o</sup>C/<sup>o</sup>F** button (2) or **-/ RCC** button (3) to change the current weather situation of your location. See figure 3 above for the weather pattern that is resembles your immediate area.

### **Barometer:**

1. The unit takes approximately 24 hours to process and analyze the recorded barometric pressure data. Until this time has elapsed, the pressure trend and weather forecasts may not reflect actual weather forecast for your area.

### **Reading Pressure trend:**

1. Recorded memory of the barometric pressure changes are displayed with 3 arrows to show pressure trend.

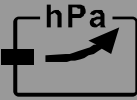
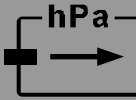
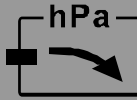
Increasing	Steady	Decreasing
		

**Note:** It is only possible to measure the barometric pressure trend properly when the unit remains at the same altitude. When moving around at different altitudes within a short period of time, the air pressure and the barometric pressure will change. The pressure trend will only be correct and regulate the has remain at a constant altitude for 24 hours or more.

### To recall recorded pressure history reading

The barometric pressure reading is recorded at an hourly interval and can be recalled and displayed up to previous 12 hours.

Press **HISTORY** button (5) repeatedly to view pressure recorded in the past hours. **-1 HR** indicates the pressure of the previous hour. The pressure reading history will appear for 20 seconds before the current pressure returns.

### RCC Synchronization:

Where ever available, this clock will automatically synchronize with the radio control towers at the following time: 02:05, 03:05, 04:05, 05:05.

User may also manually synchronize the clock by following the instructions below.

Press and hold down the **-/ RCC** button (3) for approximately 3 seconds until  is flashing.

When this signal is flashing, the clock is attempting to synchronize with the radio control.



will flash when a strong signal is received and the clock will synchronize with the

radio control. This process can take up to 7 minutes.  will stop flashing and will be displayed once the signal is received and in synchronization.

 will not be displayed if the clock is not able to synchronize within this period of time. User may manually synchronize again at a later time or the clock will automatically attempts to synchronize at the above mentioned time.

When the clock is attempting to synchronize, press down the **-/ RCC** button (3) to cancel RCC synchronization.

Please note all other clock/ weather station settings seize to function when the clock is in RCC synchronization mode. Wait until the clock is no longer attempting to synchronize or it is synchronized to set other clock and weather station function.

If the alarm goes off during synchronization mode, RCC synchronization will seize immediately. Follow the above instructions again to set synchronization.

## RCC Zone Offset

This clock is equipped with radio controlled time adjustment. The user will need to work out the time zone signal they receive at their current location and make (any) adjustment as required. This function also allows for daylight saving adjustment. Contact your local weather bureaus or authorities for more information.

Press **-/ RCC** button (3) once for +1 time zone.

Press **-/ RCC** button (3) once again for +2 time zone.

Press **-/ RCC** button (3) once again for -1 time zone.

Press **-/ RCC** button (3) once again for same time zone.

## To set time manually:

Hold down the **MODE** button (1) for approximately 3 seconds until the display is flashing. Press **+/<sup>o</sup>C/<sup>o</sup>F** button (2) or **-/ RCC** button (3) to change the hour setting.

Press **MODE** button (1) again. Press **+/<sup>o</sup>C/<sup>o</sup>F** button (2) or **-/ RCC** button (3) to change the minute setting.

Press **MODE** button (1) again. Press **+/<sup>o</sup>C/<sup>o</sup>F** button (2) or **-/ RCC** button (3) to toggle between am / pm and 24 hour clock

Press **MODE** button (1) again to confirm settings. Display will no longer flash.

## To see alarm time:

Press **MODE** button (1) once and alarm time 1 will be shown as indicated by  .  
Press **MODE** button (1) again and the current time will be shown.

## To set alarm time:

Press **MODE** button (1) once and alarm time 1 will be shown as indicated by  .

Press and hold **MODE** button (1) for approximately 3 seconds until the digits flash.

Press **+/<sup>o</sup>C/<sup>o</sup>F** button (2) or **-/ RCC** button (3) to change the hour setting.

Press **MODE** button (1) again.

Press **+/<sup>o</sup>C/<sup>o</sup>F** button (2) or **-/ RCC** button (3) to change the minute setting.

Press **MODE** button (1) again.

When alarm time is shown, press **MODE** button (1) to turn on and off the alarm.  will be shown when the alarm is on.

When alarm time is shown, press **+/<sup>o</sup>C/<sup>o</sup>F** button (2) or **-/ RCC** button (3) to turn on and off the alarm.  will be shown when the alarm is on.

The alarm will sound for 120 seconds when the preset alarm time is reached. Hit any button on the back of the clock to deactivate the alarm. The clock will automatically enter snooze mode if the alarm is not deactivated.

Hit the **SNOOZE / LIGHT** button (4) when the alarm is on to enter snooze mode.

 will flash when the clock is in snooze mode. The alarm will sound again in 5 minutes. Hit any button on the back of the clock to deactivate the alarm.

Please note that alarm time setting seizes to function when the clock is in RCC synchronization mode. Wait until synchronization has ended before setting the alarm

time.

### Configuring the Thermometer

This weather station is equipped to synchronize up to 3 remote temperature sensors. One remote temperature sensor is included. Additional remote temperature sensor is available for purchase separately. Please contact your local distributor for purchase.

#### Remote temperature sensors

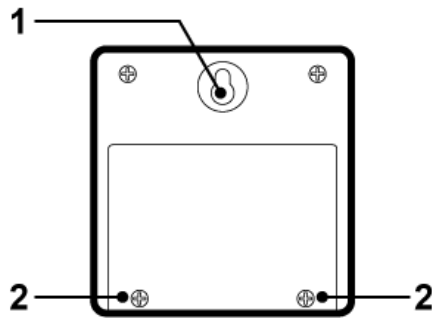

Fig. 4 Back View

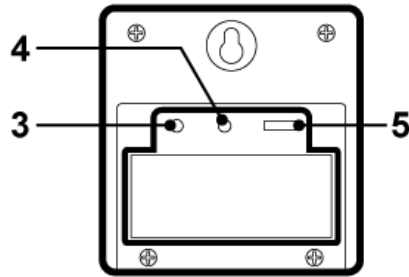

Fig. 5 Back view - open

- RTS 1. Hang hole
- RTS 2. Battery compartment screws
- RTS 3. TX button
- RTS 4. RESET button
- RTS 5. CHANNEL 123 switch

#### Batteries installation

1. Open battery compartment on the back of the unit by removing the two small screws (RTS 2) with a Philips head screwdriver. (see fig. 4)
2. Install/ replace 2 x AAA size batteries in the compartment. It is recommended that only alkaline batteries are used. Do not use rechargeable batteries.
3. The weather station is capable of receiving up to 3 different channels. Select the channel number (1, 2, or 3) by sliding the **CHANNEL123** switch (RTS 5). If you only have 1 remote temperature sensor, select 1.
4. Press the **RESET** button (RTS 4) once and the red light will flash once.
5. Replace the battery compartment on the back of the unit by tightening the two screws (RTS 2).

#### Installation

1. Place the remote temperature sensor at a desired place by mounting the unit's hang hole (RTS 1) on a screw (screw not included). Alternatively, the unit can be placed on a flat horizontal surface.
2. The unit can be placed indoors or outdoors. The unit is weather proof. Do not submerge unit in water. Do not expose unit to water for prolonged periods. Avoid accumulation of water and or snow on unit. Avoid exposing unit to direct sunlight. Remove unit from the exterior in

extreme or harsh weather, including but not limited to hurricane, typhoon, and cyclones seasons. Do not place the unit in area of high winds.

3. Do not place the remote temperature sensor more than 30 meters (98 feet) from the receiving weather station. The remote temperature sensor is most effective if there are no obstruction and interference between the remote temperature sensor and the weather station. The remote temperature sensor might have to closer than 30 meters if the weather station is not able to receive any signals. This is due to obstructions and interference. The user might need to experiment with various locations to get the best reception.

### Configuring Weather Station to receive remote temperature signals.

1. Follow the above instructions to set up remote temperature sensor.
2. Press and hold "Channel" button (6) on weather station for 3 seconds.



will flash. This will reset all temperature memories.

3. The weather station will begin scanning for signals for channel 1. As soon as signals are received for channel 1, the temperature will be displayed. The weather station will automatically scans for the other channels. It will scan each channel for approximately 3 seconds before skipping to the next channel.
4. Once all your channels are received press **CHANNEL** button (6) once to confirm the channel.  will no longer be displayed.
5. The weather station will receive a new signal automatically every 30 seconds to update the remote temperature.
6. Press **CHANNEL** button (6) on weather station repeatedly to toggle between channel 1, channel 2 and channel 3.



7.  will be displayed if any of the remote temperature sensor's battery needs replacing.

1. Temperature **MAX/ MIN** button (7) to display maximum recorded temperature, minimum recorded temperature, and current temperature. **MAX** indicates maximum temperature. **MIN** indicates minimum temperature
2. Press and hold **MAX/ MIN** button (7) for approximately 3 seconds to reset the maximum and minimum temperature and humidity records.

### Temperature display



1. The **IN** temperature displays the indoor temperature. It is the temperature of the location of the weather station.
2. The **OUT** temperature displays the temperature of the remote temperature sensors.
3. Press **CHANNEL** button (6) on weather station repeatedly to display the temperature of channel 1, channel 2 and channel 3.

4. When  is shown, the display will automatically show through all the remote sensors channel. Press **CHANNEL** button (6) to cancel.

### **Celsius / Fahrenheit**

1. Press **+/<sup>o</sup>C/<sup>o</sup>F** button (2) to toggle between displaying the temperature in Celsius and Fahrenheit.

### **Temperature Trend**

1.  indicates the temperature is in a increasing trend.
2.  indicates the temperature is in a no change trend.
3.  indicates the temperature is in a decreasing trend.

### **Warnings**

- Do not subject the unit to excessive force, shock, dust, temperature or humidity.
- Do not immerse the unit in water.
- Dispose the complete unit when battery is no longer charging or when the unit is no longer displaying the temperature and / or humidity.
- Do not remove any screws.
- Do not dispose this unit in a fire. IT MAY EXPLODE.
- Keep unit away from small children. The unit or parts of the unit might be a choking hazard.
- Never attempt to recharge the batteries in any other methods.
- Dispose the unit legally.
- Recycle when possible.

### **Specifications**

Indoor temperature range: 0°C to 50°C ( 32°F to 122°F)

Outdoor temperature range: -20°C to 50°C ( -4°F to 122°F)

Relative humidity range: 20% - 95%

Barometric pressure range: 930 mb to 1050 mb

### **Consideration of duty according to the battery law**

Old batteries don't belong to domestic waste because they could cause damages of health and environment. End-user are committed by law to bring back needed batteries to distributors and other collecting points.