

Operation Manual
Professional Remote Weather Station

Table of Contents

	Page
1. Introduction.....	46
2. Intended use	46
Weather Station	46
System requirements for PC use.....	47
Features of the base station	47
Features of the thermo-hygro sensor	48
Features of the wind sensor	48
Features of the rain sensor.....	48
3. Safety Notes	48
4. Packaged contents	49
5. Setting up.....	50
6. Operation using cable connection or wireless 433MHz	52
7. LCD overview	54
8. Function test	55
9. Mounting	55
10. Resetting & factory settings.....	57
11. Function description.....	60
12. Operation keys.....	63
13. Basic programming modes.....	65
14. MIN/MAX programming modes	66
15. Alarm programming modes	67
16. Auto-memory for stored values	75
17. Accessories: extensions cables.....	76
18. Changing batteries.....	77
19. Interference and problems with operation	78
20. Transmission range	79
21. Cleaning and maintenance.....	79
22. Specifications.....	80

This Operation Manual is part of this product and should be kept in a safe place for future reference. It contains important notes on setup and operation.

Please visit our web site www.heavyweather.info for downloads of complete instruction manuals and the most current version of the 'Heavy Weather' software.

GB

1. Introduction

Thank you for purchasing this Professional Remote Weather Station. Designed for everyday use, the weather station will prove to be an asset of great value for your personal use in the home or office.

Please read this instruction manual thoroughly to fully understand the features and functions so that you can enjoy the safe and correct operation of this unique product.

2. Intended Use

Weather Station

The base station measures the indoor environment of its surrounding area and receives weather data from the following three outdoor sensors:

- 1) Thermo-Hygro Sensor
- 2) Wind Sensor
- 3) Rain Sensor

The received data is continuously updated to bring you the latest weather information on the base station's LCD. The thermo-hygro sensor is the main data communication unit since both the wind and rain sensors are connected to the thermo-hygro sensor for operating power and rely on it to communicate to the base station. Weather data sent from the thermo-hygro sensor can be done by wireless 433MHz transmission (up to 25 meters in open space) or by cable connection.

Using the enclosed 2 meter computer cable and CD-ROM, you can install the Heavy Weather software to your PC and upload all the received weather data from the base station. Access the latest weather information from your PC and upload up to 175 sets of recorded weather data by the base station and generate useful statistics and charts onto your spreadsheets (175 sets of data is stored in the base even if the PC is switched OFF). The software itself does not set any limits as to how many data sets that can be transferred to PC.

This weather station is designed to work easily with your PC. There are no tedious requirements to turn your PC ON or OFF, simply connect and disconnect the PC cable at any time.

GB

System Requirements for PC use:

The minimum system requirement for use of this “Heavy Weather” software is:

Operating system: Windows 98 or above

Processor: Pentium 166 MHz or above

RAM: 32MB of RAM or above

Hard disk: 20MB free space

CD-ROM drive

For full details on operation and installation of the “Heavy Weather” software refer to the PC manual in PDF format on the CD-ROM.

Features of the base station:

- Receives and displays the DCF77 radio controlled time and date
- Display of extensive weather data, in all cases with programmable alarm functions for certain weather conditions as well as records of all minimum and maximum values along with time and date of their recordings
- Indoor and outdoor temperature and relative humidity displays in degrees Fahrenheit or Celsius (user selectable)
- Indoor and outdoor relative humidity displays
- Air pressure reading in inHg or hPa, absolute or relative (user selectable)
- Detailed display of rainfall data in 1 hour, 24 hours, total since last reset (user selectable in mm or inch)
- Wind speed in mph, km/h, m/s, knots or Beaufort (user selectable)
- Wind direction display with LCD compass as well as numerical (e.g. 225°) and abbreviated characters (e.g. SW)
- Wind chill temperature display
- Dew point temperature display
- Weather forecast display by weather icons (sunny, cloudy, rainy)
- Weather tendency indicator
- Storm warning alarm
- LED back light
- Simultaneous display of all weather data with individual settings by the user
- COM port for easy connection to your PC
- All the weather data from the base station and up to 175 sets of weather history data with user adjustable measuring intervals can be recorded and uploaded to your PC

GB

Features of the Thermo-Hygro Sensor

The thermo-hygro sensor measures the outdoor temperature and relative humidity. It also collects the readings from the rain and wind sensors before transmitting the data to the base station by wireless 433MHz or by the 10 meter cable included in this set.

Features of Wind sensor

The wind sensor measures wind speed and wind direction and sends the data to thermo-hygro sensor which in turn transmits the data to the base station. Operating power is taken from the thermo-hygro sensor using a 10 meter cable connection.

Features of Rain sensor

The rain sensor measures the rainfall and sends the data to thermo-hygro sensor which in turn transmits the data to the base station. Operating power is taken from the thermo-hygro sensor by a 10 meter cable connection.



3. Safety Notes

- Damage caused by failure to comply with this instruction manual will invalidate any guarantee! The manufacturer and supplier will not be held liable for actions due to failure to comply with this instruction manual or from data inaccuracies that may occur with this product!
- In case of harm or damage to a person or property caused by improper handling or failure to comply with this instruction manual, the manufacturer and supplier cannot be held liable.
- For reasons of safety and operation, alterations to this device are strictly prohibited.
- To operate the weather station, use only supplied adaptor and batteries of the recommended type.
- Do not leave used-up batteries in the device as these may corrode and release chemicals that may damage the unit.
- Inserting batteries in an incorrect polarity will cause damage to this product.
- This product is not a toy kept out of the reach of children.
- Do not dispose new or used batteries to fire as they may explosion or release dangerous chemicals.
- This product is not to be used for medical purposes or for public information.

GB

4. Packaged Contents

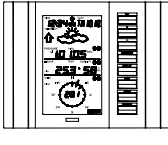
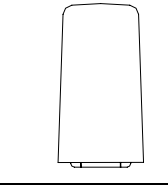
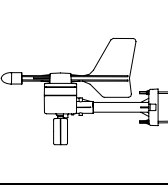
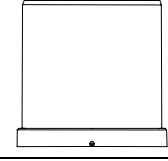
Before setting up, carefully unpack the contents onto a table or flat surface and check that the following are complete:

Item:	Consisting of:	Fittings:	Illustration:
Base Station	<ul style="list-style-type: none"> Main unit 	<ul style="list-style-type: none"> AD/DC 230V power Adaptor - optional use (included) 	
Thermo-Hygro Sensor	<ul style="list-style-type: none"> Main unit Rain protection cover 	<ul style="list-style-type: none"> 10 meter cable - optional connection to the base station (included) Wall mounting screws Plastic anchors for screws 	
Wind Sensor	<ul style="list-style-type: none"> Main unit with wind vane 10 meter cable (already attached to the main unit) Mast holder 	<ul style="list-style-type: none"> 2 x U-bolts for mast holder 4 x Washers 4 x Nuts 1 x screw (to fix main unit to the mast holder) 	
Rain Sensor	<ul style="list-style-type: none"> Main unit (base and funnel) 10 meter cable (already attached to the main unit) 		
Heavy weather PC software	<ul style="list-style-type: none"> CD-Rom format (English, German and French languages only) 	<ul style="list-style-type: none"> 2 meter PC cable for PC connection - optional use (included) 	

5. Setting up

Firstly, choose to use the adaptor (included in this set) or batteries for operation. Both these methods allow for operation of using wireless 433MHz transmission or cable connection between the base station and the sensors and setting up for both methods is as follows:

Base Station:

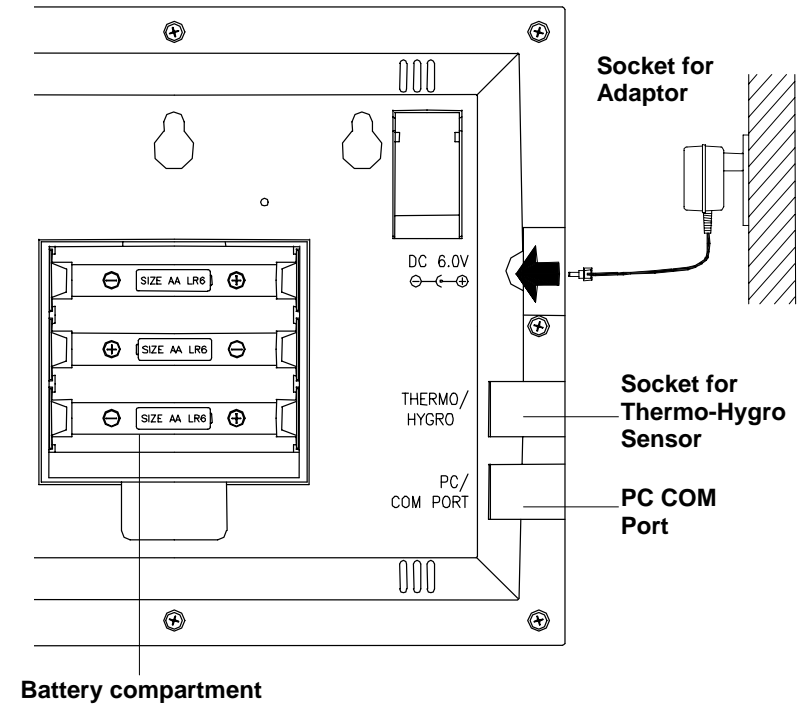

Setting up using batteries:

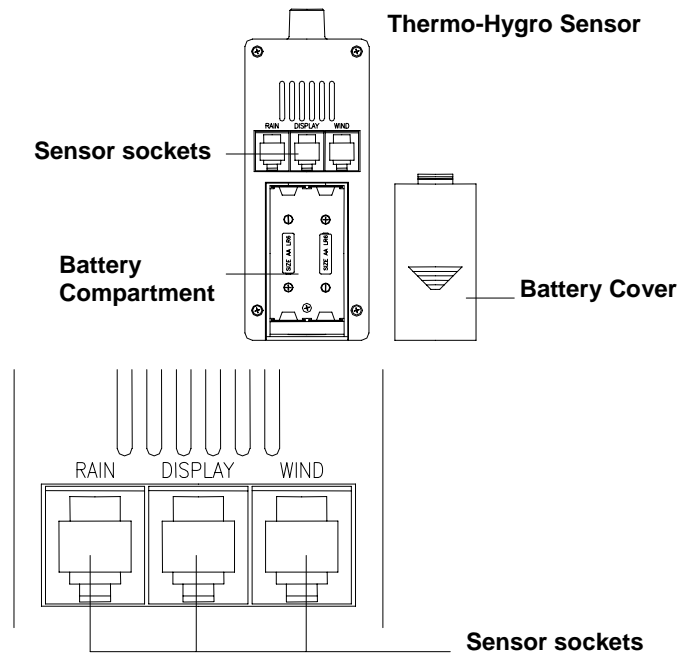

Important: To avoid operating problems, please take note of battery polarity if inserting any batteries

- 1) Pull away the rain cover of the thermo-hygro sensor to reveal the three sockets (for the wind sensor, rain sensor and the base station)
- 2) Connect the attached cables of wind and rain sensors to the corresponding sockets of the thermo-hygro sensor by clicking them into place
- 3) Open the battery cover of the thermo-hygro sensor located below the three sockets and insert 2 x AA, IEC LR6, 1.5V batteries and close the cover
- 4) Open the base station's battery cover located at the back of the unit and insert 3 x AA, IEC LR6, 1.5V batteries into the battery compartment and close the battery cover

GB

Setting up using the AC adaptor:

- 1) Power up all the sensors as described in setting up using batteries above
- 2) Using the AC adaptor (included), plug it into the mains outlet and power up the base station by inserting the adaptor jack into the 6.0V DC socket located on the side of the base station

Every time the thermo-hygro sensor is powered up (for example after a change of batteries), a random security code is transmitted and this code must be synchronized with the base station to receive weather data.

When the base station is powered up, a short beep will sound and all LCD segments will light up for about 5 seconds before it enters into a 15 minute learning mode to learn the sensors security code. After the learning mode (or by pressing the MIN/MAX key at anytime), the base station will start the DCF77 radio controlled time reception.

Note for DCF77 Radio Controlled Time:

The time and date display is based on the signal provided by a highly accurate Caesium atomic clock operated by the Physikalisch Technische Bundesamt in Braunschweig (Germany). This radio-controlled clock does not only provide for the weather station's time and date display but also functions as the time source for all of this weather station's memory and history values using time and date information.

LCD backlight:

When using the power adaptor, the LCD backlight is switched on continuously. Under battery operation, the LCD backlight is switched on for 15 seconds intervals when any key is pressed.

6. Operation using cable connection or wireless 433MHz

Cable Connection:

Using this method of operation will provide interference free transfer of the weather data from the sensors to the base station. The data sending interval from the sensors to the base station will also be more frequent compared to using 433MHz transmission and will result in higher power consumption. Therefore batteries will have a shorter life span for cable connection compared to using 433MHz.

GB

To operate using cable connection, simply use the enclosed 10 meter cable and connect the thermo-hygro sensor to the base station. Once the connection is detected, the base station will automatically continue reading the data from the sensor.

The user may at any time switch from cable connection to using 433MHz (or vice versa) by simply disconnecting (or connecting) the cable from the base station to the sensor. When the base station detects no cable connection to the sensors, the existing data reading interval is changed to the new reading interval, i.e. using cable connection is every 8 seconds data reading interval or from 32 seconds - 128 seconds intervals when using 433MHz (depending on wind speed)

Using the AC adaptor to operate the base station will also supply power to the sensor if the cable is connected to it. Batteries used for 433MHz transmission may be left in the sensor when using cable connection for power back-up in case of AC power failure. A loss of power would desynchronize the base station and the sensor and no weather data will be received. To Synchronize the units so that the weather data can be received, press and hold the PLUS(+) for 2 seconds. However in general, batteries that will not be used for long periods should be removed to avoid leakage.

Wireless 433MHz transmission:

Using 433MHz wireless transmission of weather data from the sensor to the base station will provide users greater freedom as to where units can be positioned without the need to be restricted by cable.

Note:

If no outdoor weather data is displayed or the signal to the sensors is lost during setting up, mounting, changing of batteries to the sensor or plugging or unplugging cables, simply press and hold the PLUS(+) key for 2 seconds and a short beep will sound to synchronize the base station to sensors. Without being synchronized, weather data will not be received.

7. LCD Overview

The following illustration shows the full segments of the LCD for description purposes only and will not appear like this during normal operation and use.

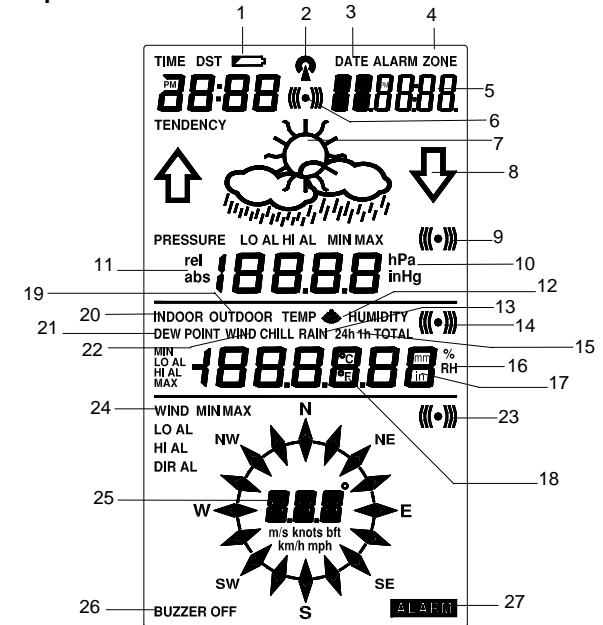

1. Low battery indicator
2. DCF77 radio controlled time icon
3. Date display
4. Time zone display
5. Date, seconds, alarm time and time zone
6. Alarm icon
7. Weather forecast icons
8. Weather tendency indicator
9. Pressure alarm display
10. hPa/inHg air pressure unit
11. Pressure units (relative or absolute)
12. 433MHz reception icon
13. Rainfall display
14. Indoor, outdoor, humidity, dew point, wind chill, rainfall alarm icon
15. 24h, 1h or total hour display
16. Humidity display as RH%
17. Rainfall units (inch or mm)
18. Temperature display units (°C or °F)
19. Outdoor temperature/humidity display
20. Indoor temperature/humidity display
21. Dew point temperature display
22. Wind chill temperature display
23. Wind alarm icon
24. Wind information for Min/Max speed and wind speed low, high, direction alarm
25. Wind direction and speed (m/s, knots, Beaufort, km/h or mph) display
26. Alarm buzzer ON/OFF icon
27. General alarm icon

8. Function test:

Once the weather station is powered up, perform a function test by checking that the weather data is received. To do this, press the either DISPLAY, PRESSURE or WIND keys to toggle through the relevant LCD sections:

- 1) Indoor temperature and humidity
- 2) Outdoor temperature and humidity
- 3) Outdoor wind chill
- 4) Dew point
- 5) Rainfall 24 hour
- 6) Rainfall 1hour
- 7) Rainfall Total
- 8) Relative and absolute pressure
- 9) Wind speed, wind direction and wind direction in degrees

If any readings cannot be received from the sensors, lines (- -) will be displayed in the respective weather sections of the LCD. In this case, check that all cables are correctly inserted into the correct sockets and press and hold the PLUS(+) key for 2 seconds and a short beep will sound to synchronize the base station to the sensors otherwise no weather data will be received.

Some weather readings such as wind speed and direction may not appear immediately on the LCD if the wind-fan or vane of the wind sensor is moved. This is due to the set reading time intervals for the wind readings. However the current wind speed or direction will be displayed once the time reading interval is reached. For rainfall, the interval readings may take up to 2 minutes before the data is displayed on the LCD.

9. Mounting

Important Note

Prior to drilling mounting holes and permanently affixing any of the units, please ensure the following points are considered:

- Cable lengths of the units meet with your distance requirements at the point of fixing
- Signals from the sensors can be received by the base station at points of mounting
- Radio controlled time signal can be received at the point of mounting

GB

Base Station

With two foldable legs at the back of the unit, the base station can be placed onto any flat surface or wall mounted at the desired location by the hanging holes also at the back of the unit. It is important to check that the 433MHz (if using wireless connection) and the DCF77 radio controlled time signal can be received before permanently mounting any of the units. Should the base station not display the 433MHz weather data from the sensors or the radio controlled time from the desired location, then relocate the units. Once the signals are received, the system can be affixed. Also if you have selected to use cable connection, ensure that distances can reach all desired locations before affixing any unit permanently

Mounting the Wind Sensor onto a mast

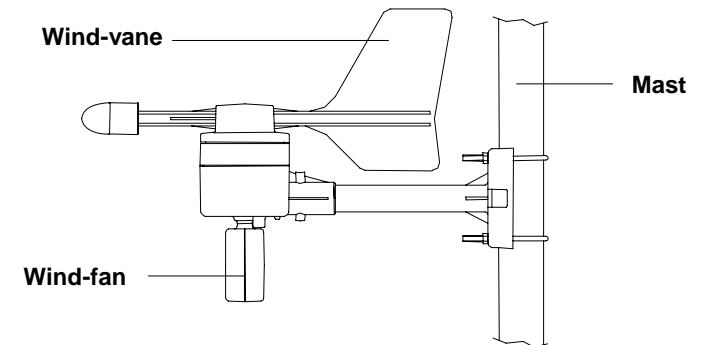

Firstly, check that the wind-fan and the wind-vane can rotate freely before fixing the unit. For correct and accurate readings it is important to mount the sensor so that the front (marked E) is pointing in East-West direction. The wind sensor should now be mounted using the screw provided onto a mast to allow the wind to travel around the sensor unhindered from all directions (ideal mast size should be from Ø16mm – Ø33mm).

Once the wind sensor is fixed onto the mast, connect the cable to the corresponding thermo-hygro sensor socket so that operating power supply can be received and data can be transmitted to the base station.

GB

Mounting the Rain Sensor

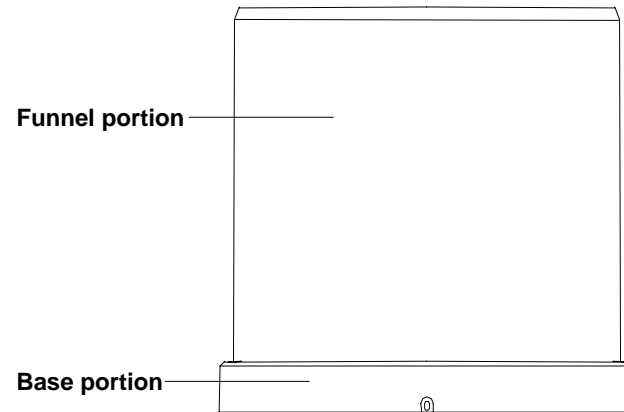

For best results, the rain sensor should be securely mounted onto a horizontal surface about 1 meter above the ground and in an open area away from trees or other coverings where rainfall may be reduced causing inaccurate readings.

When securing into place, check that rain excess will not collect and store at the base of the unit but can flow out between the base and the mounting surface (test by pouring clean water).

After mounting the rain sensor, connect the cable to the thermo-hygro sensor at the corresponding socket so power supply can be received and data be transmitted to the base station

The rain sensor is now operable. For testing purposes, very slowly pour a small amount of clean water into the rain sensor funnel. The water will act as rainfall and will be received and displayed at the base station after about 2 minutes delay i.e. when the reading interval is reached (to clear this testing data on the base station, refer to the section "**MIN/MAX Mode**" below).

GB

Mounting the thermo-hygro Sensor

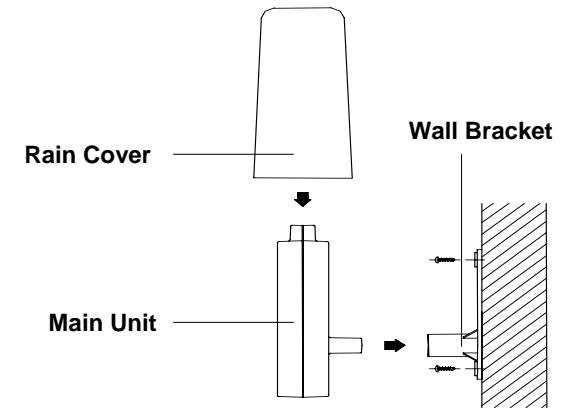

An ideal mounting place for the thermo-hygro sensor would be the outer wall beneath the extension of a roof, as this will protect the sensor from direct sunlight and other extreme weather conditions.

To wall mount, use the 2 screws to affix the wall bracket to the desired wall, plug in the thermo-hygro sensor to the bracket and secure both parts by the use of the supplied screw and ensure that the cables from the wind and rain sensors are correctly plugged in otherwise data transmission errors could occur.

10. Resetting & factory settings:

As previously mentioned, in the event of a power reset to the sensor (for example a change of batteries), the base station has to synchronize to the sensor again otherwise no weather data will be received. To do this, simply press and hold the PLUS(+) key for 2 seconds and a short beep will sound to synchronize the base station to the sensor. When the units are synchronized, the data will be received again and the base station will return to normal operation mode.

Do not reset the power of the base station otherwise all 175 sets of recorded weather history data for transferring to the PC will be lost (for full details of PC use, please see PC user manual in the enclosed Heavy Weather CD-ROM).

GB

However if you wish to make a full reset of the base station and return to the original factory settings, simultaneously press and hold the PRESSURE and WIND keys for about 5 seconds. The base station will beep once and the entire LCD will light up for 5 seconds and go back to the original factory settings. This process with clear all previous user defined values and all weather history recordings.

Factory default settings:

The following table shows the factory default values of the weather station:

Matter:	Default Setting:	
Time	0:00	
Date	01.01.2001	
Time zone	0	
Alarm time	0:00	
Relative air pressure	1013.0 hPa	
Weather-picture threshold	3 hPa	
LCD contrast level	5 (1-8 levels)	
Rainfall per impulse	0.518mm	
Storm alarm	5 hPa	
Relative air pressure alarm	960.0 hPa (low)	1040.0 hPa (high)
Indoor temperature alarm	10.0°C (low)	30.0°C (high)
Outdoor temperature alarm	0.0°C (low)	40.0°C (high)
Indoor humidity alarm	35%RH (low)	65%RH (high)
Outdoor humidity alarm	45%RH (low)	70%RH (high)
Wind chill alarm	10.0°C (low)	30.0°C (high)
Dew point alarm	0.0°C (low)	30.0°C (high)
Rainfall 24h alarm	50.0mm	
Rainfall 1h alarm	1.0mm	
Wind Speed	1km/h (low)	100km/h (high)
Wind direction alarm	None set	

Note:

All alarm default values are deactivated at the start up and any alarm must be activated by the user otherwise it will not sound.

11. Function Description of the Weather Station

After setting up, the following data will be displayed in different sections on the LCD. If this is not the case please observe the notes on "Interferences" below.

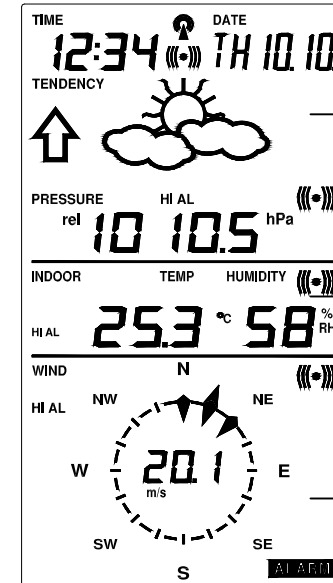

LCD Section 1:

Time, date, seconds, time zone, weather forecasting icons with tendency arrows, air pressure, and respective alarms sections

LCD Section 2:

Indoor and outdoor temperature and relative humidity, wind chill, dew point, rainfall, and respective alarms sections

LCD Section 3:

Wind direction, wind speed, and respective alarms sections

Time & Date (LCD Section 1)

If the DCF77 icon (icon 2) is ON and not flashing, it means that the DCF77 radio-controlled time and date has been received. Press the PLUS(+) key to change the format of date display between date/month/year, weekday/date/month, seconds, alarm set time and time zone.

Weather forecasting (LCD Section 1)

The three weather icons Sunny, Cloudy and Rainy represent the weather forecasting. There are also two weather tendency indicators to show the air pressure tendency either side of the weather icons.

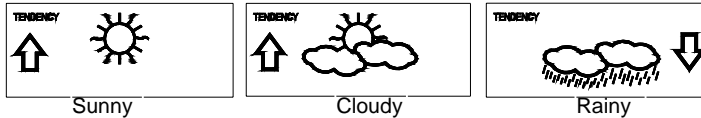

Notes to hPa sensitivity setting for weather forecasting:

The hPa (Hekto-Pascal) pressure sensitivity can be set to suit the user's requirement for weather forecasting from 2 hPa to 4 hPa (see **Basic Programming** below). For areas that experience frequent changes in air pressure (which does not necessarily reflect a change in the weather) requires a higher hPa setting compared to an area where the air pressure is stagnant. For example if 3 hPa is selected, then there must be a fall or rise in air pressure of at least 3 hPa before the weather station will register this as a change in weather.

Air Pressure (LCD Section 1)

The air pressure reading is displayed here. Press the **PRESSURE** key to toggle between relative and absolute air pressure displays.

Notes to Absolute and Relative Air Pressure:

Absolute air pressure provides the display of the true measured air pressure of the current time and location. This is not programmable and the absolute air pressure range of the weather station is from 300 hPa to 1099 hPa (standard air pressure at an altitude of 9,100 meters is around 300 hPa).

Relative air pressure is the one value that is calculated back to sea level from the local absolute air pressure and can thus be taken as a reference for weather condition and weather development for the entire country. It can be programmed to represent your local surroundings. Since the relative air pressure is also the one value given by various newspapers, TV and radio broadcasting stations in their daily weather forecasts for their respective locations, users can set the relative air pressure of the weather station to this value to represent readings your their area (see **Basic Programming Modes** below).

GB

Weather Data (LCD Section 2)

Indoor temperature and humidity are displayed simultaneously in this section. Use the **DISPLAY** key to toggle through the displays for other weather information:

- Outdoor temperature/humidity
- Outdoor wind chill
- Outdoor dew point
- Rainfall 24h
- Rainfall 1h
- Rainfall total.

Notes to Dewpoint and Windchill:

Air can at a certain temperature only carry a certain amount of water (water vapor), which also increases and decreases with temperature. If the air temperature decreases below the so called dewpoint (saturation point), the excessive water vapor will condense and fall out in form of dew, fog or rain. At a temperature of e.g. 15°C and a relative humidity of 50% the dewpoint will be about 5°C, at 80% humidity about 12°C. At a relative humidity of 100% saturation is reached, i.e. the dewpoint is 15°C. At a dewpoint below freezing the fallout will become frost or snow.

Windchill has been introduced for battle planning during World War II. It represents not the real measured but the one temperature a person feels in open area under the influence of wind and cold. Windchill is laid out in tables for various temperatures and wind speeds. At an outdoor temperature of e.g. 8°C and calm winds a person moving at a speed of 6 m/s will already feel a windchill temperature of 0°C.

Wind Data (LCD Section 3)

The current wind direction will be displayed on the LCD compass on the wind section. Press the **WIND** key to toggle between wind direction as numerical (e.g. 225°) and abbreviated characters (e.g. SW) as well as numerical wind speed display inside the compass circle.

GB

12. Operation keys

The base station has 8 keys for easy operation. Please refer to the following table for use and function of each key: Further descriptions of the key functions with regard to their immediate range of application can be found in the Programming modes:

SET - key	<ul style="list-style-type: none"> - In normal mode to enter the manual basic programming mode - In basic programming mode to select the following setting modes: - LCD contrast setting - Manual time setting (hours/minutes) - 12/24 time format display - Calendar setting (year/month/date) - Time zone setting - °C/°F temperature setting - Wind speed unit setting - Rainfall unit setting - Pressure unit setting - Relative air pressure setting - Weather picture threshold setting - Storm warning setting - Acoustic storm alarm setting - In setting modes confirmation of the selected values - In alarm modes alarm ON/OFF - In alarm mode to enter programming of alarm values (long pressing) - To exit MIN/MAX modes
PRESSURE - key	<ul style="list-style-type: none"> - Toggle between Absolute and Relative air pressure displays
DISPLAY - key	<ul style="list-style-type: none"> - Toggle between the following current/maximum/minimum display modes: - Indoor temperature and humidity - Outdoor temperature and humidity - Outdoor wind chill - Outdoor dew point - Rainfall (24h, 1h, total)
WIND - key	<ul style="list-style-type: none"> To toggle between the following settings: - Wind speed - Wind direction - Wind direction display in degrees

GB

ALARM - key	<ul style="list-style-type: none"> - In normal mode to enter the alarm programming mode - In alarm programming mode to select the following setting modes: - Time alarm setting - Indoor temperature alarm (high & low) - Outdoor temperature alarm (high & low) - Indoor humidity alarm (high & low) - Outdoor humidity alarm (high & low) - Outdoor wind chill alarm (high & low) - Outdoor dew point alarm (high & low) - Rainfall alarm (24h, 1h) - Pressure alarm (high & low) - Wind speed alarm (high & low) - Wind direction alarm - In setting modes confirmation of the selected values - To exit MIN/MAX modes - To reset general alarm symbol
MIN/MAX - key	<ul style="list-style-type: none"> - In normal display mode to toggle between display of MIN/MAX values - To toggle between MIN/MAX values in MIN/MAX mode - To exit any programming mode
PLUS(+)- key	<ul style="list-style-type: none"> - In normal display mode to toggle between format of date display, seconds, time alarm and time zone - To increase the values in the setting modes - To exit MIN/MAX modes - In normal display mode to re-enter data learning mode (long pressing for 2 seconds)
MINUS(-)- key	<ul style="list-style-type: none"> - In normal display mode to enable/disable the buzzer alarm (long pressing) - To decrease the values in the setting modes - In basic programming mode acoustic storm alarm ON/OFF - To turn the alarms off 24 hours when the alarm is sounding - In MIN/MAX modes to resets recorded values and recorded dates and times

GB

13. Basic Programming Modes

Manual Setting modes

The manual setting mode allows the user to change several basic settings, which is done by accessing one mode after the other simply by pressing the SET key. After the final mode, or if no key is pressed for 30 seconds, the manual setting returns to the normal display mode.

The manual setting takes the user through the following modes:

1. 8 level LCD contrast setting (default level 5)
2. Manual time setting (hours/minutes)
3. 12/24h time display select (default 24 hours)
4. Calendar setting (year/month/date)
5. Time zone setting ± 12 hours (default 0)
6. Temperature display unit degree Celsius or Fahrenheit (default degree Celsius)
7. Wind speed display units in m/s, km/h, mph, Beaufort, knots (default setting km/h)
8. Rainfall display in mm or inch (default setting mm)
9. Air pressure display in hPa or inHg (default setting hPa)
10. Relative air pressure setting from 920.0 hPa – 1080.0 hPa (default 1013.0 hPa)
11. Weather forecast sensitivity setting 2 hPa – 4 hPa (default 4 hPa)
12. Storm warning sensitivity setting 3 hPa - 9 hPa (default 5 hPa)
13. Acoustic storm alarm On/OFF (default ON)

To change any of the above values, once you are in the setting mode, use the PLUS(+) or MINUS(-) keys to select the values followed by the SET key to enter the next setting. Continue to press the SET key to toggle through the setting mode until the LCD returns to the normal display mode or press the MIN/MAX key at any time to exit.

Note!

Keeping the PLUS(+) or MINUS(-) key depressed when setting certain units in the manual setting mode will increase/decrease digits in greater steps.

GB

Manual time setting

The base station will continue to scan for the radio controlled time signal from 2am-6 am each day (winter time) or from 3am-6am (summer time) despite it being manually set. During reception attempts the DCF tower icon will flash.

- If reception has been unsuccessful, then the DCF77 tower icon will not appear but reception will still be attempted the following hour within the time frame
- If reception has been successful, the received time and date will overwrite the manually set time and date and no further reception is attempted until the following day

14. MIN/MAX Programming Modes

MIN/MAX display Mode

The MIN/MAX Mode provides the user with information about the MIN/MAX values of all weather data together with the time and date at which these values were recorded.

Entering each MIN/MAX mode

In the normal display mode for e.g. the indoor temperature and humidity, press MIN/MAX key to toggle the display between the maximum, minimum and current records. While the maximum or minimum values are shown press the DISPLAY key once to show the time and date that value was received. Now press the MIN/MAX key to toggle from the minimum and maximum readings and the time and dates the records were received are also shown. Still in the MIN/MAX mode (where the time and date for a value are shown), press the DISPLAY key to move through each respective unit as follows:

- **Indoor temperature** (max or min with time and date)
- **Indoor humidity** (max or min with time and date)
- **Outdoor temperature** (max or min with time and date)
- **Outdoor humidity** (max or min with time and date)
- **Outdoor wind chill** (max or min with time and date)
- **Outdoor dew point** (max or min with time and date)
- **Rainfall 24 hours** (max or min with time and date)
- **Rainfall 1 hour** (max or min with time and date)
- **Rainfall total** (max only with time and date)

GB

When in any of the above modes, press the MIN/MAX key to toggle between the maximum or minimum values of those records and their respective time and dates will also be shown.

For the wind and pressure minimum and maximum readings, the same would apply except that the WIND or PRESSURE keys would be used instead of the DISPLAY KEY.

Exiting the MIN/MAX modes

If the maximum and minimum modes with times and dates are displayed, press the PLUS(+) key twice to return the normal display mode.

Resetting the MIN/MAX records

Whilst in the minimum or maximum mode, the time and dates are also displayed along with the recorded values. If the MINUS(-) key is pressed whilst any of these values are displayed, that particular minimum or maximum record will be reset to current reading together with the current time and date with the exception of the following:

- The first case is Rainfall Total, which has neither maximum nor minimum records since it will show only the total rainfall. Pressing the MINUS(-) key, will reset the rainfall total value to zero and the time recording to current time.
- The second case is Rainfall 24h or 1h, which records maximum rain count only for these respective times. Pressing the MINUS(-) key in either of these two modes will reset the rain count to the current rain count and time and date.

15. Alarm Programming Modes

Alarm Modes

As well as the normal time alarm, this feature will allow users to set a range of specific alarms to meet specific weather and temperature conditions set by the user. The weather station allows for the following 13 alarm modes to be set:

1. Time alarm
2. Indoor temperature high alarm and low alarm
3. Outdoor temperature high alarm and low alarm

4. Indoor humidity high alarm and low alarm
5. Outdoor humidity high alarm and low alarm
6. Wind chill high alarm and low alarm
7. Dew point alarm high alarm and low alarm
8. Rainfall 24h alarm
9. Rainfall 1h alarm
10. Pressure high alarm and low alarm
11. Wind speed high alarm and low alarm
12. Wind direction alarm
13. Storm warning alarm

Setting Alarms:

For alarm setting, press the ALARM key once whilst in normal operation mode to enter the normal alarm time and by further pressing the ALARM key will toggle through each of the alarm modes:

Note:

The alarm icon will automatically appear upon pressing the SET key to tell the user the alarm is activated. Further pressing the SET key will deactivate/reactivate the alarm.

Time alarm setting

- 1) Press the ALARM key to enter the normal time alarm
- 2) Press and hold the SET key to enter the alarm hour time set mode (the hour digits will flash) and set the desired hour by using the PLUS(+) or MINUS(-) keys
- 3) Press the SET key to enter the alarm minute time set mode (the minutes digits will flash) and set the desired minutes using the PLUS(+) or MINUS(-) keys
- 4) Press ALARM key to confirm followed by the MIN/MAX key to return to the normal display mode.

Indoor temperature high alarm and low alarm setting

- 1) Press the ALARM key to enter the normal time alarm
- 2) Press the ALARM key again to enter indoor temperature high alarm set mode
- 3) Press and hold the SET key to enter the indoor temperature high setting values (digits will start flashing) and set the desired indoor temperature high by using the PLUS(+) or MINUS (-) keys

GB

GB

- 4) Press ALARM key to confirm and press the MIN/MAX key to return to the normal display mode or press the ALARM once more to toggle to the indoor temperature low alarm set mode.
- 5) Press and hold the SET key to enter the indoor temperature low setting values (temperature digits will start flashing) and set the desired indoor temperature low by using the PLUS(+) or MINUS(-) keys
- 6) Press ALARM key to confirm and press the MIN/MAX key to return the normal display mode or press the ALARM once more to toggle to another alarm setting mode.

Outdoor temperature high alarm and low alarm setting

- 1) Press the ALARM key to enter the normal time alarm
- 2) Continue to press the ALARM key until you reach the outdoor temperature high alarm set mode
- 3) Press and hold the SET key to enter the outdoor temperature high setting values (temperature digits will start flashing) and set the desired outdoor temperature high by using the PLUS(+) or MINUS (-) keys
- 4) Press ALARM key to confirm and press the MIN/MAX key to return to the normal display mode or press the ALARM once more to toggle to the outdoor temperature low alarm set mode.
- 5) Press and hold the SET key to enter the outdoor temperature low setting values (digits will start flashing) and set the desired outdoor temperature low by using the PLUS(+) or MINUS(-) keys
- 6) Press ALARM key to confirm and press the MIN/MAX key to return the normal display mode or press the ALARM once more to toggle to another alarm setting mode.

Indoor humidity high alarm and low alarm setting

- 1) Press the ALARM key to enter the normal time alarm
- 2) Continue to press the ALARM key until you reach the indoor humidity high alarm set mode
- 3) Press and hold the SET key to enter the indoor humidity high setting values (% digits will start flashing) and set the desired indoor humidity high by using the PLUS(+) or MINUS (-) keys
- 4) Press ALARM key to confirm and press the MIN/MAX key to return to the normal display mode or press the ALARM once more to toggle to the indoor humidity low alarm set mode.

- 5) Press and hold the SET key to enter the indoor humidity low setting values (digits will start flashing) and set the desired indoor humidity low by using the PLUS(+) or MINUS(-) keys
- 6) Press ALARM key to confirm and press the MIN/MAX key to return the normal display mode or press the ALARM once more to toggle to another alarm setting mode.

Outdoor humidity high alarm and low alarm setting

- 1) Press the ALARM key to enter the normal time alarm
- 2) Continue to press the ALARM key until you reach the outdoor humidity high alarm set mode
- 3) Press and hold the SET key to enter the outdoor humidity high setting values (digits will start flashing) and set the desired outdoor humidity high by using the PLUS(+) or MINUS (-) keys
- 4) Press ALARM key to confirm and press the MIN/MAX key to return to the normal display mode or press the ALARM key once more to toggle to the outdoor humidity low alarm set mode.
- 5) Press and hold the SET key to enter the outdoor humidity low setting values (digits will start flashing) and set the desired outdoor humidity low by using the PLUS(+) or MINUS(-) keys
- 6) Press ALARM key to confirm and press the MIN/MAX key to return the normal display mode or press the ALARM once more to toggle to the to enter another alarm setting mode.

Wind chill high alarm and low alarm setting

- 1) Press the ALARM key to enter the normal time alarm
- 2) Continue to press the ALARM key until you reach the wind chill high alarm set mode
- 3) Press and hold the SET key to enter the wind chill high setting values (digits will start flashing) and set the desired wind chill high by using the PLUS(+) or MINUS (-) keys
- 4) Press ALARM key to confirm and press the MIN/MAX key to return to the normal display mode or press the ALARM key once more to toggle to the wind chill low alarm set mode.
- 5) Press and hold the SET key to enter the wind chill low setting values (digits will start flashing) and set the desired wind chill low by using the PLUS(+) or MINUS(-) keys
- 6) Press ALARM key to confirm and press the MIN/MAX key to return the normal display mode or press the ALARM once more to toggle to another alarm setting mode.

Dew point alarm high alarm and low alarm setting

- 1) Press the ALARM key to enter the normal time alarm
- 2) Continue to press the ALARM key until you reach the dew point high alarm set mode
- 3) Press and hold the SET key to enter the dew point setting values (digits will start flashing) and set the desired dew point high by using the PLUS(+) or MINUS (-) keys
- 4) Press ALARM key to confirm and press the MIN/MAX key to return to the normal display mode or press the ALARM key once more to toggle to the dew point low alarm set mode.
- 5) Press and hold the SET key to enter the dew point low setting values (digits will start flashing) and set the desired dew point low by using the PLUS(+) or MINUS(-) keys
- 6) Press ALARM key to confirm and press the MIN/MAX key to return the normal display mode or press the ALARM once more to toggle to another alarm setting mode.

Rainfall 24h alarm setting

- 1) Press the ALARM key to enter the normal time alarm
- 2) Continue to press the ALARM key until you reach the rain 24 hour alarm set mode
- 3) Press and hold the SET key to enter the rain setting values (digits will start flashing) and set the desired rain values by using the PLUS(+) or MINUS (-) keys
- 4) Press ALARM key to confirm and press the MIN/MAX key to return to the normal display mode or press the ALARM key once more to toggle to another alarm setting mode.

Rainfall 1h alarm setting

- 1) Press the ALARM key to enter the normal time alarm
- 2) Continue to press the ALARM key until you reach the rain 1 hour alarm set mode
- 3) Press and hold the SET key to enter the rain setting values (digits will start flashing) and set the desired rain values by using the PLUS(+) or MINUS (-) keys
- 4) Press ALARM key to confirm and press the MIN/MAX key to return to the normal display mode or press the ALARM key once more to another alarm setting mode.

Pressure high alarm and low alarm setting

- 1) Press the ALARM key to enter the normal time alarm
- 2) Continue to press the ALARM key until you reach the pressure high alarm set mode
- 3) Press and hold the SET key to enter the pressure setting values (digits will start flashing) and set the desired pressure high by using the PLUS(+) or MINUS (-) keys
- 4) Press ALARM key to confirm and press the MIN/MAX key to return to the normal display mode or press the ALARM key once more to toggle to the pressure low alarm set mode.
- 5) Press and hold the SET key to enter the pressure low setting values (digits will start flashing) and set the desired pressure low by using the PLUS(+) or MINUS(-) keys
- 6) Press ALARM key to confirm and press the MIN/MAX key to return to the normal display mode or press the ALARM once more to toggle to another alarm setting mode.

Wind speed high alarm and low alarm setting

- 1) Press the ALARM key to enter the normal time alarm
- 2) Continue to press the ALARM key until you reach the wind speed high alarm set mode
- 3) Press and hold the SET key to enter the wind speed setting values (digits will start flashing) and set the desired wind speed high by using the PLUS(+) or MINUS (-) keys
- 4) Press ALARM key to confirm and press the MIN/MAX key to return to the normal display mode or press the ALARM key once more to toggle to the wind speed low alarm set mode.
- 5) Press and hold the SET key to enter the wind speed low setting values (digits will start flashing) and set the desired pressure low by using the PLUS(+) or MINUS(-) keys
- 6) Press ALARM key to confirm and press the MIN/MAX key to return the normal display mode or press the ALARM once more to toggle to another alarm setting mode.

Wind direction alarm setting

- 1) Press the ALARM key to enter the normal time alarm
- 2) Continue to press the ALARM key until you reach the wind direction alarm set mode
- 3) Press and hold the SET key to enter the wind direction setting values.

- 4) Using the PLUS(+) or MINUS (-) keys select the desired wind direction and use the SET key to confirm or cancel each direction input
- 5) Press ALARM key to confirm and press the MIN/MAX key to return the normal display mode or press the ALARM once more to toggle to another alarm setting mode.

Storm warning alarm setting

Unlike the other weather alarms, the storm warning alarm is set by entering the main manual setting mode as follows:

- 10) Press the SET key to enter the manual setting mode
- 11) Continue to press the SET key until the Storm warning icon flashes (tendency arrow flashing downwards with the pressure values flashing)
- 12) Set the desired hPa pressure value (3 hPa - 9 hPa) using the PLUS(+) or MINUS(-) keys
- 13) Press the MIN/MAX key to confirm and return to the normal display.

Storm warning alarm ON/OFF

After storm warning alarm setting, the next mode to appear after pressing the SET key is the storm warning ON/OFF. Use the PLUS(+) or MINUS(-) key to change the status to AON or AOFF. Default setting is ON:

Should the air pressure drop equal or below the pre-set hPa value within the last 6 hour period, then the downward tendency arrow will flash as an indication of possible storm. The base station will take hourly measurements as a point of reference. The storm-warning indicator will stop flashing once the air pressure becomes more stable.

Master Alarm – BUZZER OFF

The time and all the weather alarms may have buzzer sound set to OFF by holding the MINUS(-) key down for about 3 seconds in normal display mode and the BUZZER OFF icon appears on the bottom left of the LCD. When the BUZZER OFF is displayed, the time and all other weather alarms when activated will only flash but not sound regardless if that particular alarm has been set to the ON. To deactivate the BUZZER OFF, press the MINUS(-) key once more.

GB

General Alarm Icon

The general alarm icon on the bottom right corner of the LCD will appear when any weather alarm is activated to show the user that a set weather condition has been reached. The activated alarm can be determined by checking the set alarm values against the MIN/MAX values reached. To deactivate the general weather alarm icon, press the ALARM key.

Important

When entering the alarm set mode for a specific weather or temperature condition, the corresponding alarm is automatically enabled (ON) when the SET key is pressed, regardless of its previous setting and the alarm value will flash to indicate that it has been activated. Press the ALARM key to confirm the setting and continue pressing the ALARM key to toggle through each alarm mode until it returns to the normal display mode or press the MIN/MAX key at any time to exit the alarm setting modes.

When a set weather alarm condition has been activated, that particular alarm will sound and flash for approximately 2 minutes but will continue to flash until weather conditions have become more steady.

Weather Alarms

The weather alarms are settable for when certain weather conditions are met according to the users requirements. For example, the user can set the thresholds for the outdoor temperature to +40°C (high) and -10°C (low), whilst only enabling the high alarm and disabling the low alarm (i.e. temperatures <-10°C won't trigger alarm, but temperatures >+40°C will).

Alarm setting	Minimum	Maximum
Storm threshold	3 hPa	9 hPa
Air Pressure	920.0 hPa	1080.0 hPa
Outdoor Temperature	-30.0°C	+69.9°C
Indoor Temperature	-9.9°C. No alarm will sound if the minimum indoor temperature alarm is set below -9.9°C.	+59.9°C
Humidity (all)	20% RH	95% RH
Rainfall 24h	0.0 mm	1000 mm.
Rainfall 1h	0.0 mm	1000 mm
Wind	0.0 m/s	50.0 m/s

GB

Hysteresis

To compensate for fluctuation of the measured data, which may cause the weather alarm to sound constantly if the measured reading is close to user set level, a hysteresis function has been implemented for each weather alarm. For example, if the high temperature alarm is set to +25°C and the current value moves to +25°C, the alarm will be activated (if it has been enabled). Now when the temperature drops to +24.9°C or below and thereafter again increases to beyond +25°C, the data will be blinking, but no alarm will be activated. It has to drop to below +24°C (with a pre-set hysteresis of 1°C) so that the alarm can be produced again. Hysteresis values for the various weather data types are given in the following table:

Weather data	Hysteresis
Temperature	1°C
Humidity	3% RH
Air pressure	1 hPa
Rainfall 24h	5.0mm
Rainfall 1h	0.5mm
Wind	10 km/h

16. Auto memory for stored values

The base station has a memory back up system, which is used to memorize user-defined settings for when the batteries are changed or if a power failure occurs. User defined units are automatically updated each time these are changed. The base station will memorize the following user defined units:

- Time zone
- 12/24h time display mode
- Unit settings (temperature, pressure, rainfall, wind)
- Air pressure offset for calculation of relative air pressure
- Weather picture threshold
- Storm warning threshold
- LCD contrast
- Alarm time
- Weather Alarm thresholds
- State of alarms (enabled/disabled)
- Rainfall total value and reset time/date

GB

17. Accessories: adding cable extensions

For your convenience, additional telephone cables to increase the connection distance between each of the units may be purchased from any reputable hardware store. Simply add these to the current cables to extend your cable connection distance.

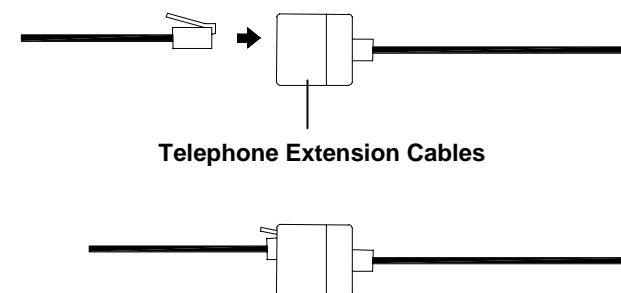

When securing the cables during mounting, ensure that base station can receive the weather data since increasing the cables lengths may also increase levels of interference and result with reception difficulties. Interference levels will greatly depend on the surrounding area for example setting up on or near metal piping may considerably reduce reception.

For best results, do not to add more than 10 meters of extension cable from item to item onto the existing cable lengths as this may reduce reception levels. Again, reception and interference levels will greatly depend on the surrounding environment at your point of mounting.

Note:

It is important to keep all the connected extension heads away from rain, moisture and other extreme weather conditions as exposure can cause short circuits and damage to this item.

GB

18. Changing batteries:

Battery change only in the thermo-hygro-sensor:

1. Open the battery cover
2. Remove the old batteries and insert with new ones of the recommended type and replace the cover

Once the sensor is powered up, press and hold the PLUS(+) key for approx. 2 seconds in the normal display mode, the base station will sound a short beep and synchronize to the sensor otherwise no weather data will be received.

Battery change only in the base station:

1. Connect power adaptor to base station and power outlet.
2. Open the battery cover located at the back of the base station.
3. Remove the old batteries, insert with new ones of the recommended type and replace the cover

This method of battery replacement will result in no loss of MIN/MAX and history data. However in case of possible power failure, the base station will lose the MIX/MAX and all weather data recordings and will need to be synchronized to the sensors again by pressing the PLUS(+) key for 2 seconds.

Note:

When batteries require replacement for the base station, the low battery indicator will light up on the LCD.



Please participate in the preservation of the environment by properly disposing of all used-up batteries and accumulators at designated disposal points. Never dispose of batteries in a fire as this may cause explosion, risk of fire or leakage of dangerous chemicals and fumes

GB

19. Interferences and problems with operation

Problem & cause	Remedy
Distance between transmitters and receiver too long.	<i>Reduce distance between transmitters and receiver to receive signal</i>
High shielding materials between the units (thick walls, steel, concrete, isolating aluminum foil and etc.)	<i>Find a different location for sensors and/or receiver. See also Item 'Transmission Range' below.</i>
Interference from other sources (e.g. wireless radio, headset, speaker, etc. operating on the same frequency)	<i>Find a different location for the sensors and/or base station. Neighbors using electrical devices operating on the 433MHz signal frequency can also cause interference with reception</i>
No Reception after adding extension cables	<i>Find a new location for the sensors and/or base station. Recommend not adding more than 10 meter extension cables between units to the existing cable lengths as this will increase the chance data reception problems.</i>
Reception then no reception - loss of transmission signal from the sensor to the base station	<i>Press and hold the PLUS(+) key for 2 seconds to synchronize the base station to the sensors for weather data reception. If still no signal, then change the sensor batteries and synchronize the units again.</i>
Poor contrast LCD or no reception or low batteries in sensors or receiver.	<i>Check the LCD contrast setting or change batteries (check low battery indicator on the LCD)</i>

Quite frequently interferences are only of a temporary nature and may be easily overcome. If there are wireless headsets, remote babysitters or other devices working on 433MHz in your house or in the vicinity, their switch-on time is mostly limited. Furthermore most of these devices allow the change to an interference-free frequency. Such measures will effectively overcome interferences.

GB

20. Transmission Range

The transmission distance from the thermo-hygro sensor to the base station in open space under optimum conditions is 25 meters. Although the signal transmission may travel through solid surfaces or objects, the following points should be avoided if possible:

- High frequency interferences of any kind.
- Constructions of any kind or trees.
- The distance of transmitter and receiver to conducting planes or object (including the human body or the ground) does influence the transmission characteristics and thus the transmission distance.
- Broadband interferences in municipal areas can reach levels reducing the signal/noise ratio over the entire frequency band, thus also reducing the transmission distance.
- Devices working close by (example a neighbor's house) may also influence reception.
- Poorly shielded PCs can cause interferences that will reduce or in some cases stop reception

21. Cleaning and Maintenance

- Clean the housing and screen of the base station only with a soft damp cloth. Do not use abrasives or solvents.
- Ensure that the rain sensor does not collect leaves or other dirt by checking the funnel for blockages every now and then. Also clean the seesaw of the sensor with a damp cloth and check by lightly tapping with your finger that it can move freely from side to side.
- Do **not** clean the funnel with the bottom half of the rain sensor attached nor the bottom part itself under running water. This may bear the danger of water entering the unit's inner parts and cause damages.
- Do not immerse the base station in water.
- Should there be damage to this product, please do not attempt to make any repairs. Please take this unit to a qualified technician. Opening or improper handling of the units will invalidate any guarantee.

GB

22. Specifications

Outdoor data

Transmission Distance in Open Field:	25 meters max.
Temperature Range	: -29.9°C to +69.9°C (show "OFL" if outside range)
Resolution	: 0.1°C
Measuring Range Rel. Humidity	: 20% to 95% (if the relative humidity is less than 20% or greater than 95%, it will display 19% or 96%)
Rain Volume Display	: 0 to 999.9mm (1h and 24h rainfall) 0 to 2499mm (Total rainfall)
Resolution	: 0.1mm
Wind Speed	: 0 to 180 km/h or 1 to 50 m/s
Resolution	: 0.1m/s
Wind Direction	: Graphic Resolution 22.5 Degrees, Numerical Resolution, Letter format

433MHz data transmission:

Measuring interval thermo-hygro sensor	: 32 sec (if wind factor > 10m/s) or 128sec (if wind factor < 10m/s) 10 minutes (if the base station fails to receive any data after 5 attempts in a row; all outdoor data readings will display "---", except for the rain value)
--	--

With wire data transmission:

Measuring interval thermo-hygro sensor	: 8 seconds
--	-------------

Indoor data

Pressure/ temperature	: 4 times per minute
Indoor Temperature Range	: -9.9°C to + 59.9°C (shows "OFL" if outside range)
Resolution	: 0.1°C

GB

Measuring Range Rel. Humidity : 20% to 95% (if the relative humidity is less than 20% or greater than 95%, it will display 19% or 96%)
Resolution : 1%
Relative humidity checking interval : every 30 seconds

Measuring Range Air Pressure : 300 hPa to 1099 hPa
(Standard air pressure at an altitude of 9,100 meters is around 300 hPa)
Resolution : 0.1 hPa

Alarm duration : 2 minutes (approx.)

Power consumption

Base Station

Batteries : 3 x AA, IEC LR6, 1.5V (Alkaline recommended)
or AC power : INPUT 230V C 50HZ (use the provided AC/DC adapter only)

Thermo-hygro sensor : 2 x AA, IEC LR6, 1.5V (or can draw power from the adapter if used)

Battery life using 433MHz: : approximately 12 months (alkaline batteries recommended)

Battery life using cable connection : approximately 6 months (alkaline batteries recommended)

Dimensions (L x W x H):

Base Station : 170 x 35 x 138 mm
Thermo-hygro sensor : 71.5 x 73 x 136 mm
Rain sensor : 140 x 70 x 137 mm
Wind sensor : 60 x 197 x 291 mm

R&TTE Directive 1999/5/EC

Summary of the Declaration of Conformity : We hereby declare that this wireless transmission device does comply with the essential requirements of R&TTE Directive 1999/5/EC.

CE 0681

For use in:
Germany, Austria, UK., France,
Belgium, The Netherlands, Italy,
Spain, Denmark, Switzerland

GB

GB

EJIN2300012